

# BIOMAT

(Biological, Mechanical and Technical Colony)

An International Space Colony

in Earth Orbit:

2050AD

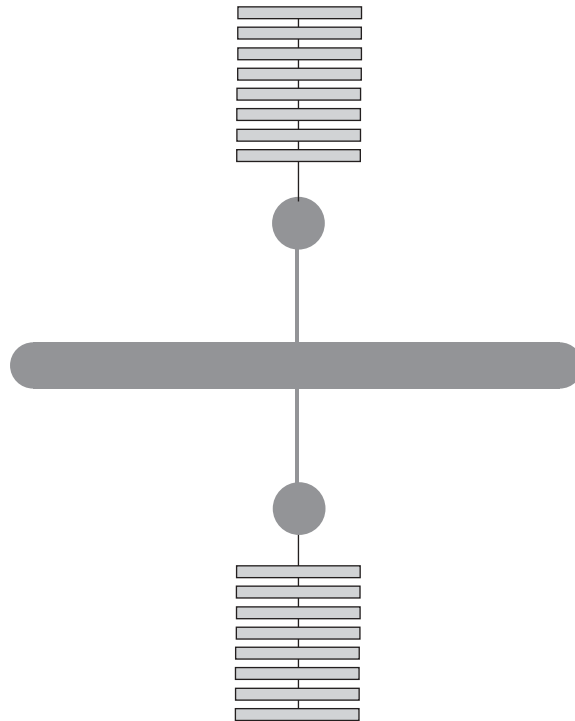

Project presented by the members of the  
Collierville High School Aerospace Design Team

Members are:

Kelly Baldwin, Jennifer Baldwin, Steven Bossé,  
Will Brian, Drew Conner, Morgan Darden,  
Ashley Kucsmus, and Alex Vranas

Advisor: Mike Baldwin

Submitted on March 31, 2004

# Contents

01.	Purpose .....	3
02.	First things first: the shuttle .....	3
03.	Where the colony is located .....	3
04.	How the Colony Works .....	4-10
	a. Putting it all together .....	4
	b. Voice-over communications .....	8
	c. Library on ePaper .....	8
	d. Circadian rhythm .....	9
05.	A colony of many missions .....	10-18
	a. Issues of living in space for prolonged periods of time .....	10
	b. Our search for life beyond Earth .....	11
	c. Good vibrations: a study of gravity waves .....	12
	d. The next big idea: nanotechnology .....	12
	e. Spinning asteroid action .....	13
	f. Dusty trails .....	14
	g. Terrestrial planet hunters .....	14
	h. Storm spotting .....	15
	i. Under the knife: the cryogenic knife .....	16
	j. A bountiful harvest: $^3\text{He}$ collection .....	16
	k. Testing 1-2-3: propulsions of the future .....	17
06.	References .....	19

## **01 – Purpose**

BIOMAT (Biological Mechanical and Technical) Colony was established as a logical next step in the exploration of space. In preparation for journeys to planets and moons in our own solar system and eventual manned expeditions across the galaxy, BIOMAT is providing a stepping stone to the future. The men and women of BIOMAT are immersed in space. They observe, analyze, calculate, design, plan, live and breathe with space in mind. Many observatories, laboratories and research facilities are housed at BIOMAT. Space habitation studies and procedures are being conducted daily in the colony. New propulsion systems are tested at BIOMAT, in addition to preparing humans for deployment to lunar mining operations (including the mining of Helium 3 [ $^3\text{He}$ ]), and deployment on deep space missions.

## **02 – First things first: the shuttle**

A new shuttle was designed specifically for BIOMAT. The new shuttle looks somewhat like a combination of a Boeing 757 passenger plane, a shuttle, and a cargo plane. It is equipped with air-breathing engines in the wings with fuel tanks and intakes which seal off once the shuttle has left the atmosphere. Robotically controlled glider external fuel tanks break away from the fuselage once the conventional single stage to orbit (SSTO) rockets fire.



**BIOMAT Shuttle**  
CREDIT: NASA

The front end of the shuttle opens like a four-part clam shell for uploading and downloading of cargo or passengers. Both cargo and passenger compartments are canister-loading. Human transport canisters are pressurized with life-monitoring systems. Cargo canisters can be pressurized or non-pressurized, depending on the cargo. Canisters are pre-loaded before being placed into the shuttle. Canisters are situated inside the

shuttle on a rail system. Hydraulic pistons at the back of the shuttle push the canisters along the rails and out into the docking bay.

Once a shuttle has arrived at BIOMAT, the docking port seals around the nose of the shuttle and the nose doors open. Large shuttles connect at docking hubs, while smaller taxi shuttles and delivery shuttles travel from the docking hub to smaller ports located throughout the toruses of the colony.



**Small Shuttle**  
CREDIT: NASA

## **03 – Where the colony is located**

BIOMAT is located at LaGrange point L1 based on an earth/moon relationship. This places BIOMAT between the earth and the moon, in earth orbit. This point was chosen because of its close proximity to both the moon and the earth, with easy accessibility to the moon for 3-Helium mining operations and establishment

of light-pollution free observatories.

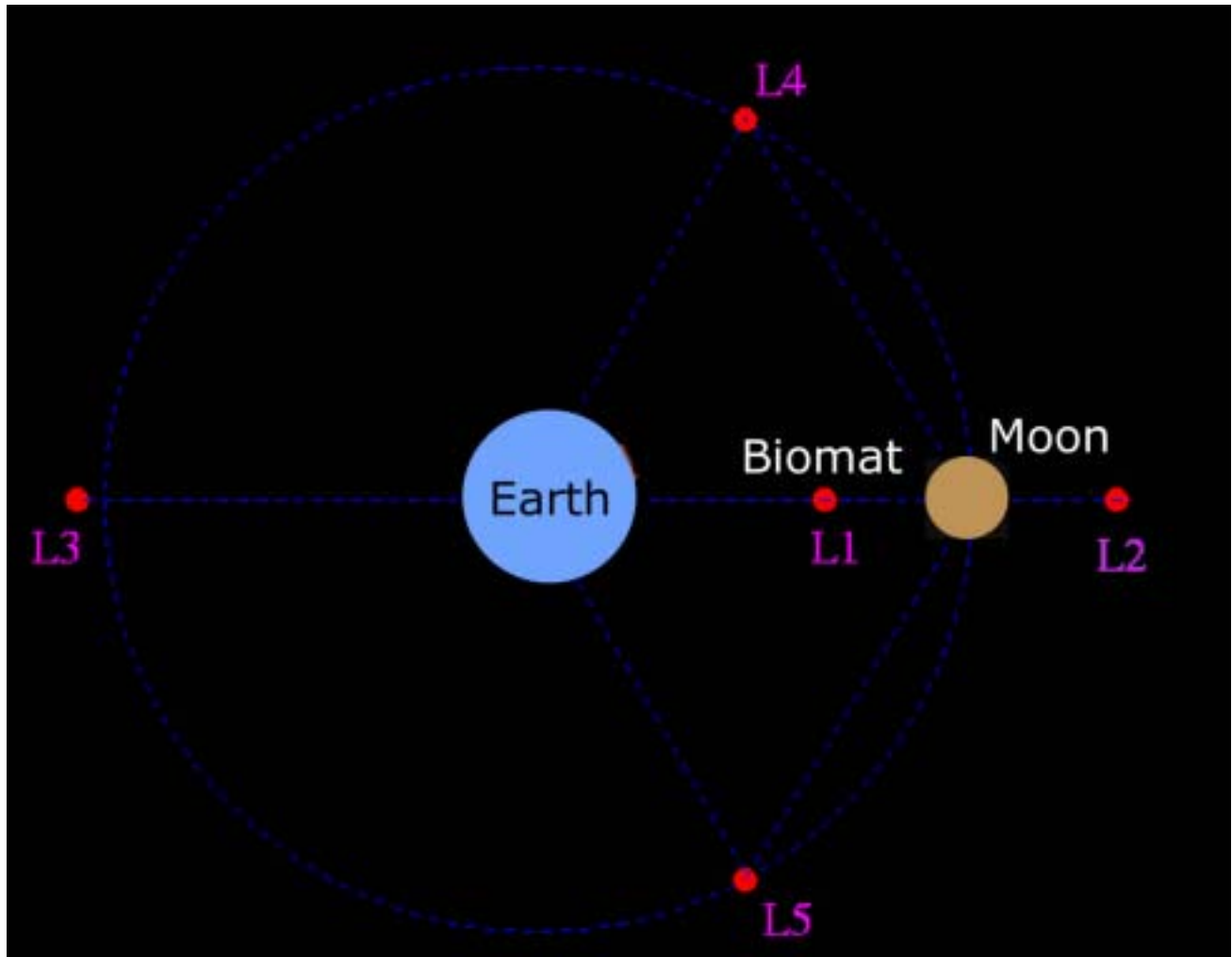

BIOMAT located at L1. Diagram credit ABC.com

## 04 – How the Colony Works

### 04a – Putting it all together

**Power:** Solar energy as main power source for the colony, with energy generated from  $^3\text{He}$  reactors on the lunar surface being used as supplemental and backup power. Solar arrays are located on the outside panels of the toruses. Additional solar panel arrays protrude from the top and bottom of the colony to provide for constant collection of solar energy.

**Toruses:** BIOMAT consists of four concentric toruses, each with a revolution speed at 9.1m/sec. The toruses are: [1] 880 yards wide; 440 yards high; 2 miles in diameter; [2] 880 yards wide; 440 yards high; 1.5 miles in diameter; [3] 880 yards wide; 440 yards high; 1 mile in diameter; [4] 880 yards wide; 200 yards high; .5 mile in diameter; and [5] sphere is 2000 feet in diameter.

TOP VIEW

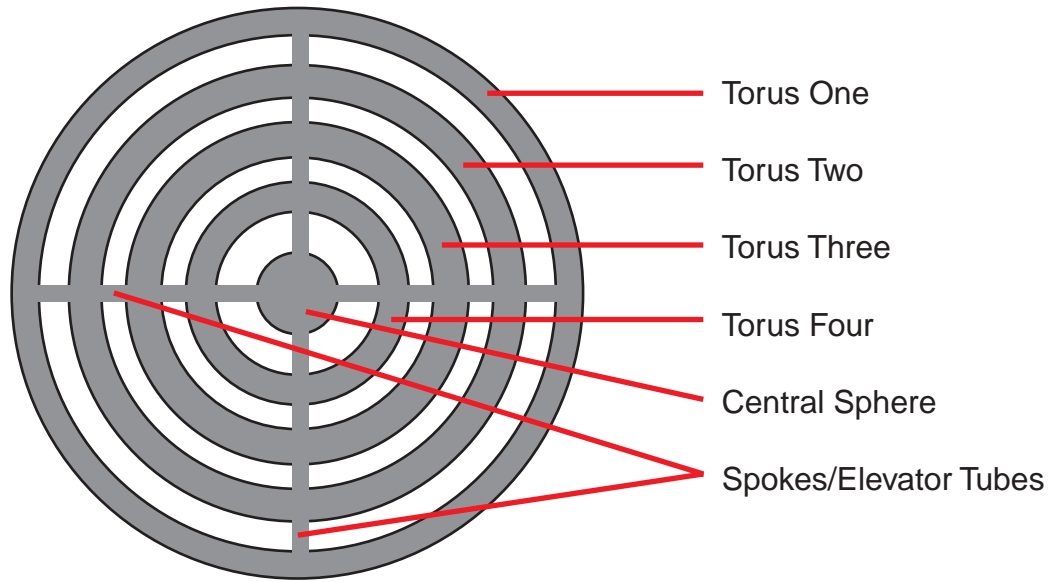

SIDE VIEW

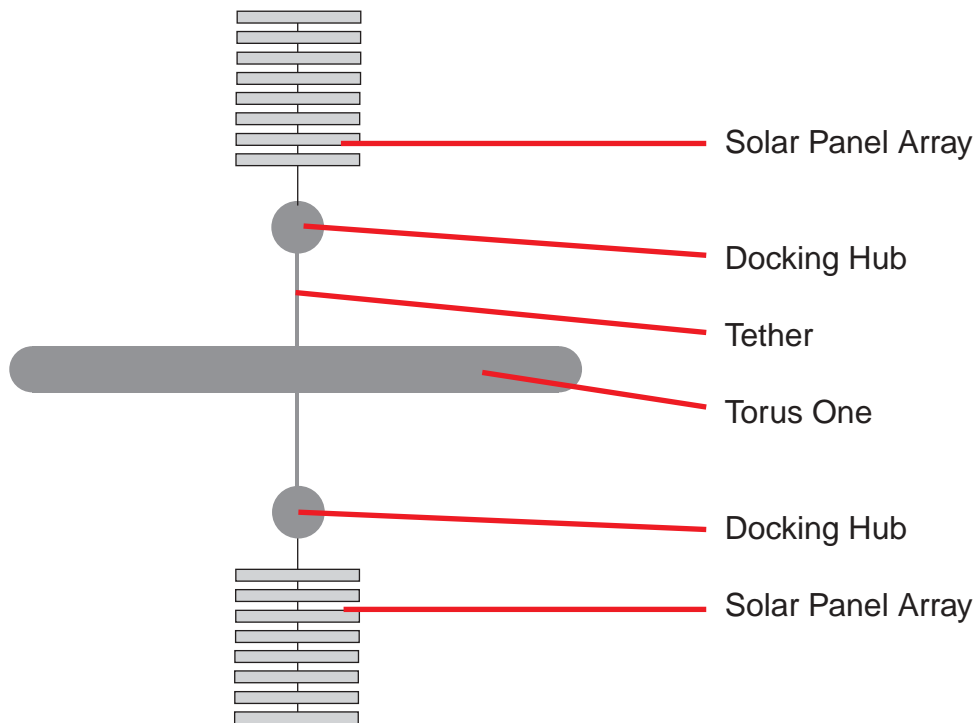

To start the colony in rotation, rocket engines were placed at regular intervals on the toruses. The rockets were fired until the rotation speed of 9.1 m/sec was accomplished. Engines were then reversed momentarily to lock the rotation speed. Thrusters are located in opposing pairs along the outside shell of the toruses. Thrusters are in opposing pairs so one could be used for acceleration and one for braking. All toruses are spinning at the same rate of speed but at different rotation frequencies, depending upon the diameter of the torus.

The outer torus (torus 4) contains the communities. Most of the recreation and entertainment is housed in torus 3, Torus 2 is reserved for work and school, and torus 1 houses BIOMAT experiments. A fusion reactor occupies the center sphere.

**Population:** A self-governing population of 16,500 permanent residents and a transient population of an additional 800 people inhabit BIOMAT. Considering the nature of this colony, most of the jobs onboard are for highly-skilled professionals such as technicians, engineers, and scientists. Although, all the positions offered in a normal earth community would also apply in the colony, from maintenance workers to medical personnel. The permanent population consists of approximately 4,500 married couples, 4,000 single men, 2,500 single women, and 1,000 children.

**Elevators:** Travel from the central hub to the outer toruses is by means of an elevator system. Elevators are self-contained in elevator tubes which traverse the spokes of the colony. Airlocks are located at the ends of the elevator tubes. Tubes do not contain air. Elevators travel on tracks with wheels similar to those on high-speed roller coasters. One set of wheels locks in at the bottom of the rail and one set of wheels locks in on the sides of the rail. At the Main Hub, the elevator tubes flair out to match the downward tilt of the elevator. Each



**BIOMAT Elevator.** CREDIT: <http://www.spaceelevator.com/>

elevator hub has a wheel shape with only the outside of the wheel rotating.

The interior of elevator cars are built like the interior of a commercial airliner, with the exception that the seats rotate 180 degrees. Passengers in the elevator cars will always be facing “forward”. When the car reaches its final destination, the seats rotate 180 degrees for the return trip.

Elevators come into a torus through the top and exit through the bottom. Elevator boarding platforms are at ground level.

**Living in BIOMAT:** Housing units are modular and prefabricated on earth for delivery to the colony. Communities in the colony look very much like zero-lot subdivisions on earth. Single family units and townhomes are available. Housing units were installed as one of the first steps of construction of the colony. The infrastructure, streets, housing, and businesses are all loaded before the outer structure and shell were placed on the toruses. Housing units are available in one-, two-, and three bedroom varieties. Housing units are equipped with full-service kitchen/dining area, living room/study, bathrooms [one or two] and bedrooms.

For your convenience, groceries and many other necessary items are ordered through the touch screen inventory system. Goods are delivered to the housing units by way of a conveyor system. Two daily, conveyor deliveries can be made. These deliveries arrive and are automatically placed on the receiving counter in your kitchen area.

Common areas and community parks throughout the colony provide residents with opportunities to watch the stars and observe the spectacular views of earth and the moon. Wide boulevards, and the ambience of the circadian sky [details in 4d] provide a relaxing and inviting atmosphere. Residents are encouraged to spend much time “outside”. Work shifts are only six hours long to provide ample opportunity for residents to enjoy their surroundings. Hanging gardens are visible throughout the communities, complete with the fresh aromas of the fruits and vegetables as they ripen. Parks and common areas appear lush and green with an abundance of trees and shrubbery.

Of course no community is complete without restaurants and shops. Most of the businesses in the communities are small “family-owned” shops to add to the ambience. Restaurants are clustered in well landscaped food courts. Some of the businesses who have chosen to locate in BIOMAT are: Kentucky Fried Chicken, Chic-fil-A, Starbucks, A&W, McDonalds, Burger King, Pizza Hut, Steak n Shake, Subway, P.F. Chang’s, Chili’s, Bennihana’s, and the Olive Garden.

Some of the main attractions for the younger residents of BIOMAT are the entertainment areas. Community parks offer ball fields and skateboarding parks, and there are movie theaters in each quadrant, but there are several one-of-a-kind attractions in BIOMAT. [1] The HoloRoom which can be programmed to create spectacular adventures for you. When you first step inside the HoloRoom, it is warm grey with overlying green gridlines. Once you are prepared for the adventure and the program is activated, the room transforms into a virtual adventure, whether it is a rockclimbing trek or a hike through a cave. The room morphs to the parameters of the program to give you the sensation of “being there”. [2] Virtual Universal Studios rides—

your feet are on the ground and you are in your seat, but you feel like you're on a wide trek through deep space, or exploring the undersea world of the Pacific, or one of many virtual rides. [3] The Ender Room based on the still-popular "Ender's Game" science fiction novel of the late 20th century. The Ender Room provides you with hours of sometimes 0G, sometimes 3G strategic and tactical team laser tag excursions. [4] First Person Video Games. Just put on the helmet and goggles and you are pulled directly into the game. Video games have never been so much fun.

### **More information**

**FOOD PRODUCTION:** Occasionally supplemental food shipments arrive from earth, but 95 percent of all food consumed on BIOMAT is produced onboard. Food production taking one of two forms: [1] Pharm Fresh food is genetically engineered and synthetically produced; and [2] hydroponic gardens throughout the colony grow an abundance of fruits and vegetables for consumption onboard. A benefit of hydroponic gardens is the oxygen by-product. O<sub>2</sub> is filtered at the top of the gardens and CO<sub>2</sub> is regulated at the bottom.

**POWER:** Most of the power supplied to BIOMAT comes from solar energy, but supplemental energy from lunar <sup>3</sup>He is processed on the moon, and generated into power in the Central Sphere Reactor. Power cables are bolted onto the elevator tubes for transport to the toruses. Electrical wiring is also placed between the toruses resulting in an additional benefit. The flow of electricity between toruses creates an electromagnetic buffer which serves as a means of eliminating friction between toruses.

**SUBSTATIONS:** If additional 0G laboratory/research space is needed, tethered substations can be fixed to the Central Sphere with jets to keep them stationary. Temporary living quarters can be established in these substations.

**STAGING AREA:** Launch platforms are an intrigue park of each docking hub. These launch platforms are used to stage expeditions for projects such as: [1] testing new propulsions; [2] construction staging area for the Martian colony; or [3] the beginning of long-range expeditions to deep space.

### **04b – Voice-over communications**

BIOMAT uses VoIP (Voice-over Internet Protocol) for earth and intercolonial communications. Handheld PCs provide the hardware for making free internet calls via onboard broadband connections. Satellite links connect BIOMAT with voice servers on earth, while a wide area network provides connections within BIOMAT. All calls, whether within the colony or to earth or lunar operations are local calls.

### **04c – Library on ePaper**

Although eInk technology attempted to replace bound books on Earth several years ago, the technol-



ogy did not catch on because it was determined that people enjoy the feel of a good book in their hands as they are reading. BIOMAT has taken the eInk technology to its logical conclusion. Paperback book-sized handheld reloadable books are standard fare in the colony. The BIOMAT library takes advantage of ePaper technology. The ePaperbacks on BIOMAT are simple to use. Wireless connections allow the user to download material from the BIOMAT library. ePaperbooks contain enough nanochip memory to contain the entire contents of the US Library of Congress, but most residents find it more desirable to download one or two books at a time and reload when they finish reading those books. eBook Skins upload to the ePaperback to give your book a graphic cover to match the content you are currently reading. If you have downloaded more than one book to your ePaperback, the cover skin will match the volume you are currently reading.

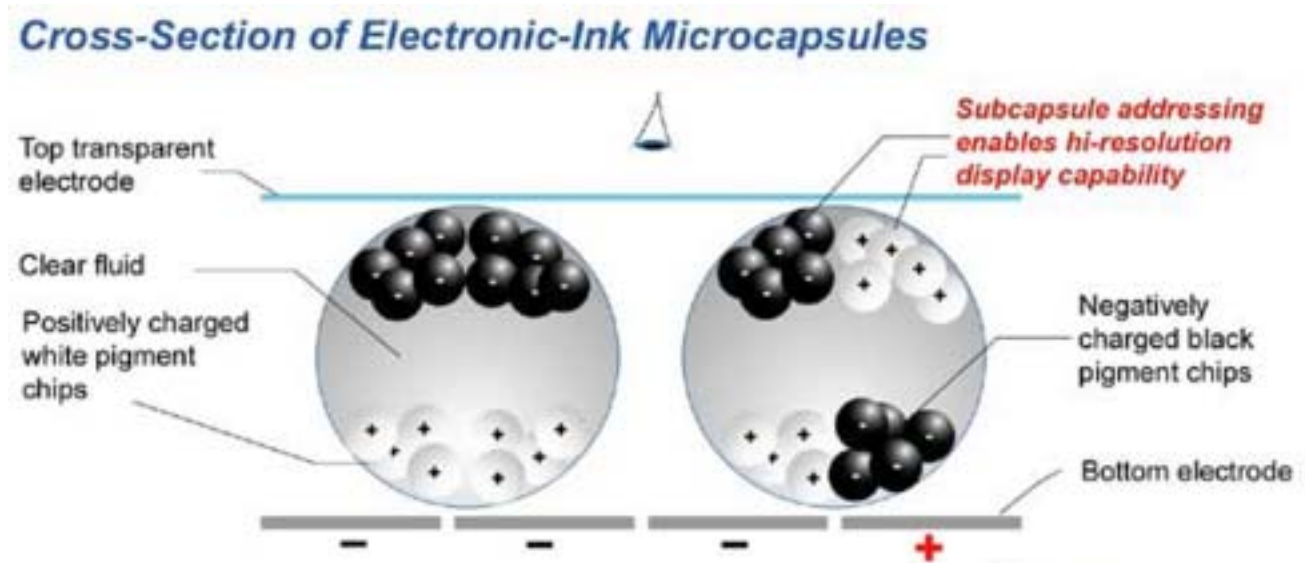

**Electronic ink:** CREDIT: eInk, Inc.

#### **I04d – Circadian rhythm**

The circadian cycle is the pattern of night and day, and the changes that occur over time in it and because of it. It drives our biological clock, which is prepared for small changes. Our biological clocks control our hormones, our sleeping habits, our eating habits, and our moods.

Without contact with the circadian cycle, our biological clocks go off 1-2 minutes daily. Over a long period of time, our perception of time can be reversed. Also, time is harder to calculate because we are unable to know how many days have actually gone by.

Clocks and watches can solve part of this problem, but will develop a second problem that will be discussed later. The mind does not take what it hears as truth. As we may believe what is said, our minds tend to reject it. In order to balance with the circadian cycle, an emulation of it is active at all times within BIOMAT.

LEDs (Light Emitting Diodes) are used to create an artificial cycle in the colony. LEDs are made more complex to change the color of a single light. This is done by combining the metals that produce cyan,

magenta and yellow light. This is useful in creating an artificial sky within the walls of BIOMAT. Each LED acts as a pixel, each controlled individually by a central computer, much like a computer monitor has independently controlled pixels.

The advantages of this system are the ability to create an organized system of the sky, sun, and stars in a realistic cycle. Also, it can be programmed to randomly lower the light and produce images of a cloudy day. The colors are realistic at dawn, morning, noon, afternoon, dusk and evening. The morning cycle starts as a yellowish-blue, and dusk ends with a red/red-orange color.

The sky is scattered with evenly spaced misters, simulating light rain. This will moisturize the air, and water the plants and trees growing in the colony.

At night, clusters of LEDs illuminate in different colors, sizes and positions in the sky. This realistically emulates constellations, star patterns and celestial events such as meteor showers, lunar events and planetary phenomenon. Lunar phases are visible.

To provide the best quality for the sky, so that the use of LEDs is not visibly obvious, thin translucent “plates” cover the entire sky. Misters are mounted outside the plates. Plates are reinforced with carbon nanotubes to provide strength and durability.

Time on BIOMAT is based on Eastern Standard Earth Time with 1200 hours being noon and 2400 hours being midnight. Temperatures will vary slightly according to which season BIOMAT is currently experiencing. Wintertime temperatures on BIOMAT will normally be in the upper 60s while summertime temperatures will range in the upper 70s to low 80s.

## **05 – A colony of many missions**

### **05a – Issues of living in space for prolonged periods of time**

Can we keep an astronaut alive for 40 years? In the conventional space stations of the early 21st century, tours of duty for astronauts was limited to a few months, and a steady stream of supplies from home was normal. A voyage to the closest Earth-like planet in another solar system is likely to involve decades of travel with no support at all. A modest supply of water, oxygen, and food on board a spacecraft must be recycled over and over with an almost 100 percent recovery rate. Scientists call it closing the loop—keeping the recycling process going for years at a time. As a precursor to interstellar flight, BIOMAT is the testing ground for issues concerning long-term flight.

**Food:** A continuous supply of food requires growing and harvesting plants. BIOMAT employs a process which maximizes the caloric yield of plants such as potatoes and wheat, while compressing the growing cycle (higher calorie food in less time). Most plants grow faster if they receive large doses of carbon dioxide, conveniently breathed out by BIOMAT residents. To maximize growth on BIOMAT, apple groves and orange groves are part of everyday life, growing in the center medians of your streets and in our community parks. Hanging gardens are also part of our normal environment on BIOMAT. Typically, the hanging gardens are located on the lower levels of the colony.

**Air Supply:** BIOMAT residents inhale oxygen and exhale carbon dioxide. Mechanical scrubbers separate the carbon dioxide from the ambient air. Chemical processes then split the bond between the two oxygen atoms and the carbon atom, recovering the O<sub>2</sub> part of CO<sub>2</sub>, closing the oxygen loop.

**Water:** Closing the water loop means purifying shower water, crop water, and waste water. High-powered lasers provide the power for isolation chambers on BIOMAT which condense vapor in the air and reprocess waste water.

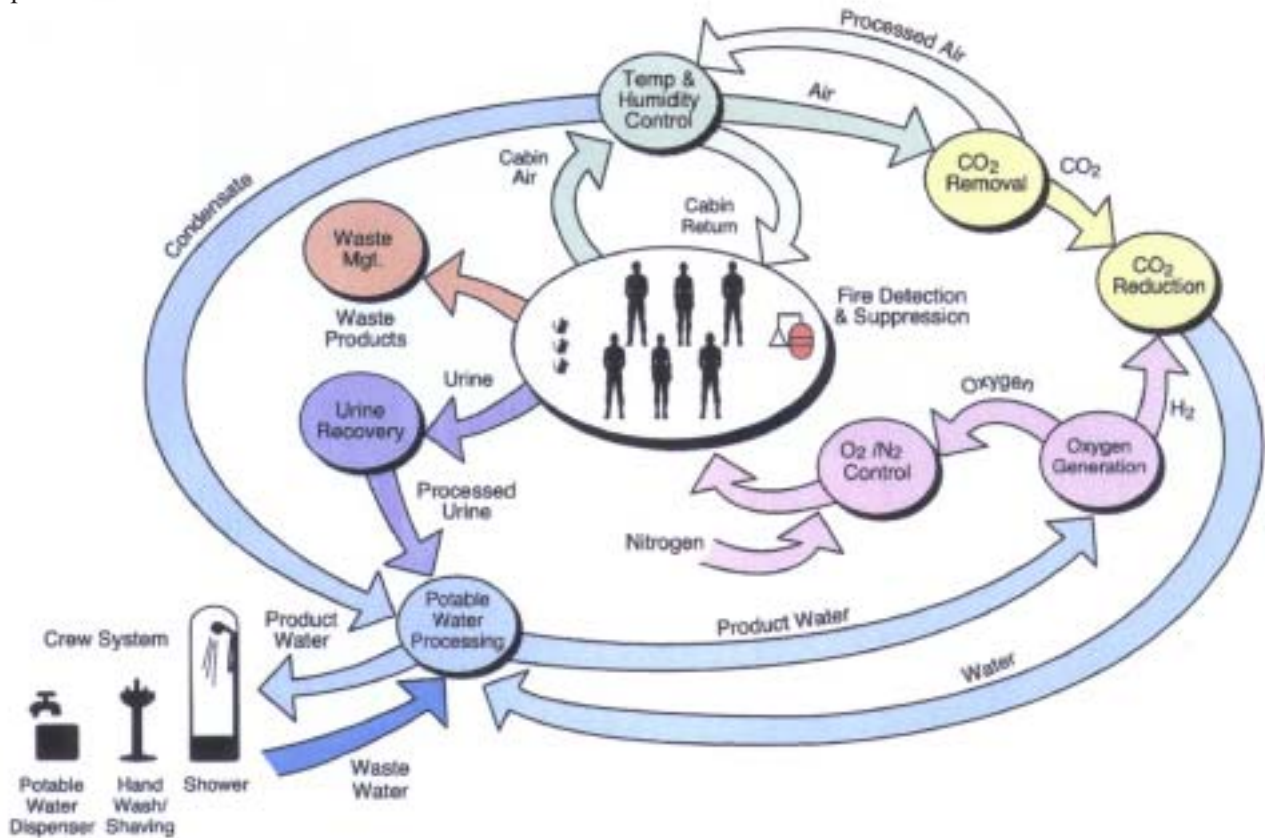

The Loop: Recycle and Reuse: Credit, Space 2100.

### 05b – Our search for life beyond Earth

When the United States space probe, Huygens, plunged through the dense atmosphere of Saturn’s moon Titan at the turn of this century, it discovered what scientists had suspected all along – nitrogen and methane [virtually no oxygen]. Huygens discovered lakes of methane on the surface of Titan. Methane is one of the precursors for the development of life.

Efforts are underway now to explore the hidden oceans of Europa, one of the moons of Jupiter. At -260 degrees F., Europa’s surface is colder you can imagine. But at least it has plenty of ice, which is covering a vast ocean of much warmer water. There are creatures on Earth that thrive in the depths of our oceans at temperatures exceeding 700 degrees F. Geologists are constantly finding new life in bizarre places, such as deep under the Earth’s crust. Microbes are more resilient than we ever imagined.

So there’s a chance we will find life in our solar system beyond Earth. The scientists, biologists,

geologists, and physicists of BIOMAT are constantly analyzing data collected from deep space probes and rovers. Only a few years ago, there were no confirmed planets in existence anywhere in our universe beyond Earth. Now we know that planets are common. If planets are common, is life common? There may be millions and millions of planets in our galaxy alone, and there may be billions of galaxies. Imagine how unlikely it is there that there is not life elsewhere. Perhaps the better question is . . . is there intelligent life elsewhere? On BIOMAT, we hope to be the first to discover life on another world!

### **05c – Good vibrations: a study of gravity waves**

BIOMAT has established an elaborate Gravity Wave Detector to measure distortions in space and time caused by supernovas, collapsing stars, and other violent events. Gravity waves are but faint whispers as they pass Earth. Our Gravity Detector is super sensitive. This device is easily misled by the more mundane vibrations of near space. Keeping the laser beams on target is difficult and many other things besides gravity waves can knock them off kilter. A heavy footstep nearby can set the light waves trembling. Because of this need for complete stillness, our Gravity Wave Detector is a self-contained unit located adjacent to BIOMAT. Droid technicians (Artificial Intelligent Human-Like Robots) monitor the unit and collected data is filtered and analyzed before it is forwarded to the technicians onboard BIOMAT.

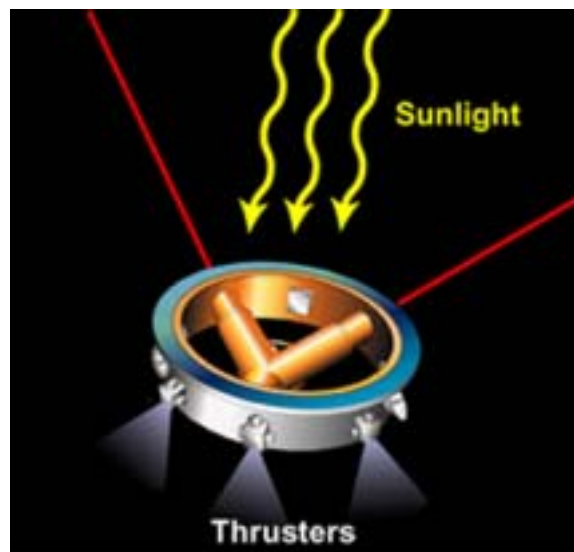

**Laser Interferometer Space Antenna: CREDIT: NASA**

### **05d – The next big idea: nanotechnology**

A carbon nanotube fiber narrower than a strand of hair has the strength to suspend an 18-wheeler. BIOMAT has been designed using carbon nanotube construction which provides the strength of steel at fraction of the weight.

Some of the uses we have found for nanofibers in BIOMAT are: [1] Complimentary metal oxide semiconductors [CMOS] memory chips; [2] Smart materials such as photorefractive polymers and self-

tinting, self-shielding glass; [3] Molecular sensors for temperature, barometric pressure, light, sound, electricity, particular molecules and specific biological targets such as bacteria, toxins, explosives and DNA; [4] Nanoscale biostructures for human body self-assembly and repair, designed to mimic bone and rebuild broken /missing areas—outer shell designed so natural that bone begins to form around it like coral on a reef or gold plating—compatible with human immune system; [5] Self-healing structures called Ionic Polar Balloon Membranes which consist of a series of balloon-shaped charged [polar] sections, each attached to a long string-like uncharged section—if the membrane is breached, the balloons immediately fill the breach; [6] Recognition Channels called siderophores which are molecules that are specifically designed to use their flexible arms studded with particular sensors containing nitrogens, sulfurs, and oxygen which capture desired metal ions—also used to permit certain molecules to pass through and others to be detained such as nutrients, wastes, and other critical ingredients; and [7] Self-healing nanocomposites for spacecraft which recover from fuel tank or fuselage damage or fabrics which change color and porosity such as a shirt made from fabric which changes from yellow, open weave on a hot day to dark blue, warm woolly fabric on cooler evenings.

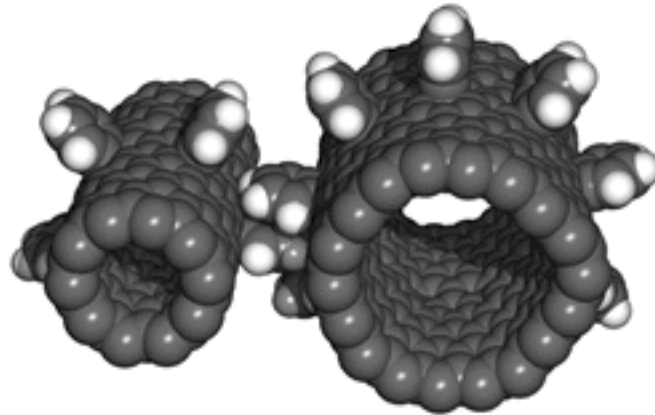

**Carbon Nanotube:** CREDIT: NASA

### **05e – Spinning asteroid action**

BIOMAT scientists are involved in a series of studies concentrating on a strange solar phenomenon. Solar rays can change an asteroid's rotation rate or even nudge it out of its orbit. Some asteroids spin at nearly the same rate and in similar directions. Solar rays warm up an asteroid's surface, just as asphalt cooks on a hot summer day on Earth. As the heat is radiated into space, the escaping energy produces a slight twisting force.

Over billions of years, this minuscule effect can significantly speed up or slow down an asteroid's spin, depending on its initial orientation. Sunlight can cause some asteroids to rotate so quickly that it flies apart, shedding rubble that then orbits like a cloud of tiny moons. Light pressure also influences an asteroid's path through space. Sunlight can slowly push one out of the asteroid belt so it becomes planet-crossing. On rare occasions, the planet the asteroid crosses could be our own.



## **05f – Dusty Trails**

One of the great advances of astronomy over the past few decades has been the discovery of planets outside our solar system. But the discovery of these planets is just a small piece of the puzzle. Planet finders on Earth generally see the biggest worlds, but they miss the smaller bodies, such as asteroids and comets, that make places like our solar system so rich and diverse. These bodies are leftover building blocks of larger worlds.

To get to these smaller bodies, astronomers on BIOMAT look for the dust scattered when objects collide. Our scientists have found hundreds of stars with dusty debris disks and have obtained images of dozens of them. These studies show that planet formation occurs elsewhere in much the same way that it did in our own solar system. Observations of debris disks around stars of different masses and ages are helping to place our solar system in context with the rest of the universe.

Our astronomers still need to piece together a detailed and consistent picture of how planets form around stars of different masses and how these planets change over time. The powerful telescope arrays of BIOMAT are helping to place the pieces of this puzzle together.

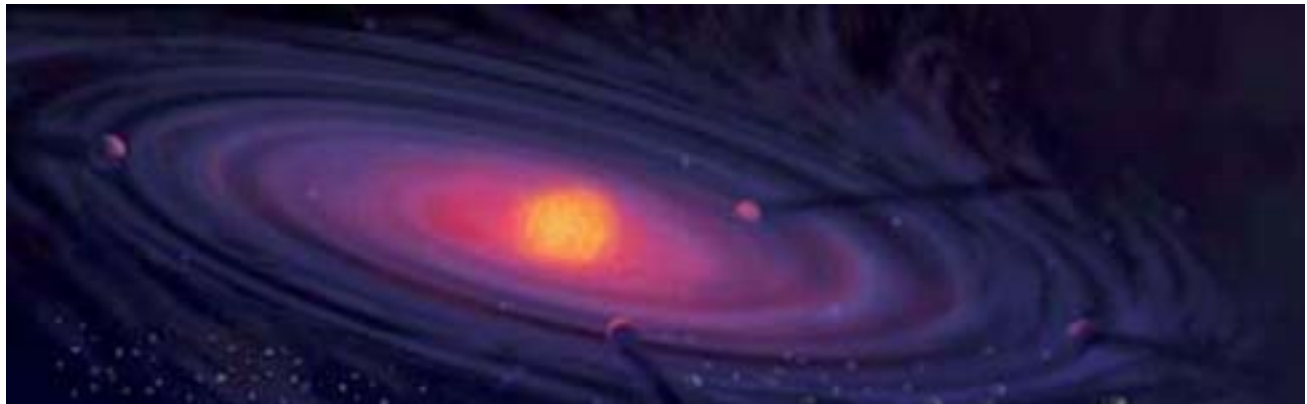

**Circumstellar Debris Disk.** CREDIT: NASA

## **5g – Terrestrial Planet Hunters**

BIOMAT is vital to the Terrestrial Planet Finder Satellite Network. 48 Planet Finder satellites encircling the Earth use onboard stellar interferometers which exploit the wave properties of light to blot out a star's rays and emphasize the disk of dust around young stars. Small gaps in the star's rays are a strong indication of a planet orbiting the star. BIOMAT astronomers and scientists analyze data received from the 48-satellite array and compile data on the terrestrial planets being discovered in star systems as far as 40 to 55 lightyears from BIOMAT.

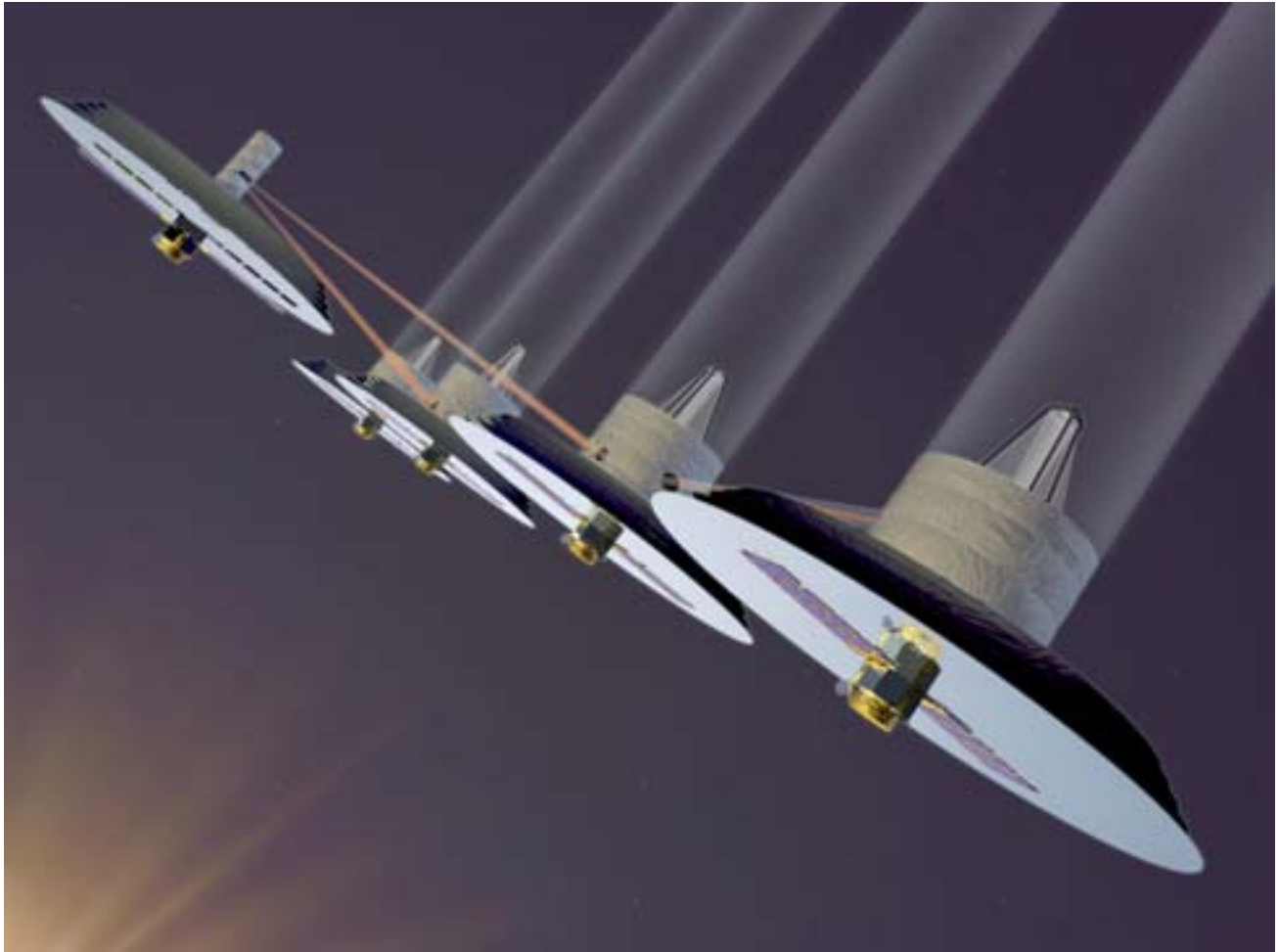

**Terrestrial Planet Finder Satellite Array.** CREDIT: NASA

## **5h – Storm Spotting**

BIOMAT Storm Stopping Team monitors storm activity from the sun. Massive sunspot groups produce incredible solar flares. Along with these bursts of electro-magnetic radiation comes enormous clouds of plasma mixed with magnetic fields. Known as coronal mass ejections (CME's), these unpredictable clouds consist of billions of tons of energetic protons and electrons. When directed earthward, CMEs can cause major problems. In the past, CMEs have struck the Earth with little or no warning. The BIOMAT Storm Spotter Team uses Solar Mass Ejection Imagers (SMEI) which track CMEs through space and time and provide Earth with an advance warning system. SMEIs can determine the speed, path and size of CMEs, which allowing for refined and reliable impact forecasts.

## **5i – Under the Knife: The Cryogenic Knife**

The BIOMAT Cryogenic Lab has made great advances in the area of cryogenic cutting. The Nitrojet, perfected in the BIOMAT Lab, slices through just about anything—steel girders, concrete slabs, stacks of fabric—and never dulls.

The supercooled nitrogen jet, which emerges from special nozzles fitted to hand-held or robotically positioned wand, seems to cleave materials so well because the dense liquified gas enters a solid's cracks and crevices and then expands rapidly, breaking up from the inside. The effectiveness of the process for various applications depends on the pressure (6,000 to 60,000 lbs/sq in.), temperature (300 to -290 degrees F) and distance to the workpiece chosen by the user. Lower pressures enable the nozzle stream to strip tough-to-remove coating off delicate surfaces better than almost any other cleaning process.

The cryogenic jet does not create secondary waste or cross-contamination; as the nontoxic, super-cooled “blade” warms, it simply vanishes into the air. Hazardous refuse created by stripping or cutting can be vacuumed up at the point of impact.

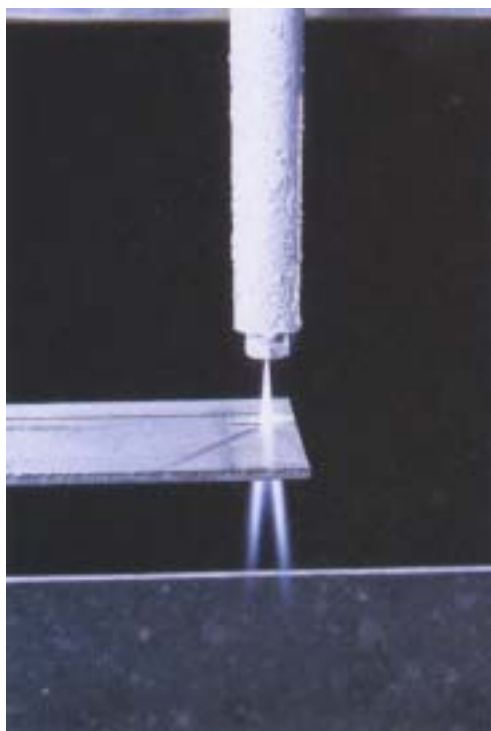

**Nitrogen Jet Knife:** CREDIT: Scientific American

## **5j – A Bountiful Harvest: $^3\text{He}$ Collection**

Deuterium [heavy H]/ $^3\text{He}$  for fusion reactors is much safer than the reactors of the late 20th and early 21st century. Fusion plants fueled by  $^3\text{He}$  (Helium-3) cost less than conventional reactor fuels.  $^3\text{He}$  takes much longer than tritium to become hazardous, while it creates less toxic by-products, and is less vulnerable to theft by terrorists. Due to the low cost of operating spacecraft between the lunar surface and BIOMAT,



opportunities for harvesting  $^3\text{He}$  from the lunar surface are great.

$^3\text{He}$  is a stable, lighter isotope of ordinary helium. It is odorless, colorless and tasteless. Natural abundance of  $^3\text{He}$  is  $1.38 \times 10^{-6}$ .  $^3\text{He}$  is primarily shipped and used in gaseous form for detectors, NMR tracers, spectroscopy, low temperature physics, lasers, dilution refrigerators and Research and Development laboratory research. Spectra Gases Material Safety Data Sheets (MSDS) are available for  $^3\text{He}$  and should be used as guidelines in regards to first aid, methods of storage, handling and general use of  $^3\text{He}$ .

The moon has plenty of  $^3\text{He}$ . When the solar winds (the rapid stream of charged particles emitted from the sun) strikes the moon,  $^3\text{He}$  is deposited in the powdery soil. Over billions of years the layers of  $^3\text{He}$  have built up. Meteorite bombardment of the lunar surface disperses the particles throughout the top several meters of the lunar surface.

To extract the  $^3\text{He}$ , the lunar soil is superheated by using a lead tube vacuum hose which contains a fusion-powered heater. Fusion chambers the size of basketballs, which rely on electrostatic focusing of ions into the chamber, have been set up at regular intervals on the lunar surface for processing of the  $^3\text{He}$ . Nonhuman workers (moonbots) harvest and process the  $^3\text{He}$ .  $^3\text{He}$  harvested from the lunar surface is used to help provide power for BIOMAT as well as being shipped to earth to help supplement earth resources.  $^3\text{He}$  is worth \$4 billion/ton in terms of energy equivalent to oil.

### **5k – Testing 1-2-3: Propulsions of the Future**

A rocket's speed is limited to about twice the velocity of its nozzle exhaust. The shuttle blows out its exhaust at less than three miles per second, so it cannot exceed more than about six miles per second. At that rate it would take 120,000 years to reach Alpha Centauri. To get there in a human lifetime, a rocket would have to travel at least 3,000 times faster than current propellants, such as liquid hydrogen and kerosene, can thrust. At BIOMAT we are continuing to research and test a variety of interstellar propulsion systems.

#### **PROPULSION SYSTEMS COMPARED:**

[1] NUCLEAR FISSION: Pros—could be feasible soon; Cons—very heavy, needs processed fuel, requires massive radiation shielding; has limited top speed and range.

[2] NUCLEAR FUSION: Pros—lighter than a fission engine, less radiation, possibly refuelable; Cons—heavy, has a limited range, technology not yet practical.

[3] ANTIMATTER: Pros—most efficient rocket, best top speed, longest range of the three atomic engines (fission, fusion and antimatter); Cons—heavy, antimatter technology still under development.

[4] LASER SAIL: Pros—high speed, no fuel onboard, technology available now; Cons—massive laser infrastructure, can only go where laser points.

[5] FUSION RAMJET: Pros—near light speed, unlimited interstellar travel in any direction; Cons—requires major advances in physics and engineering knowledge.

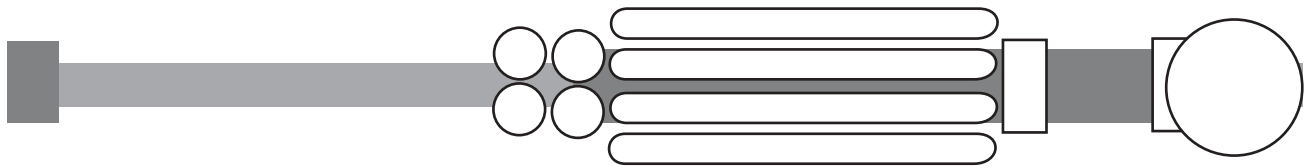

ANTIMATTER PROPULSION

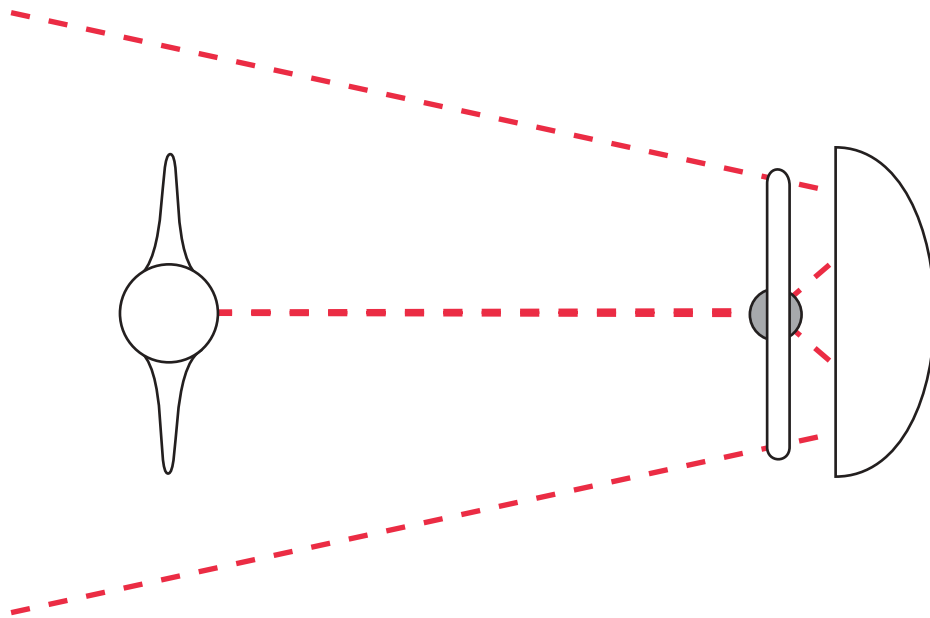

LASER SAIL

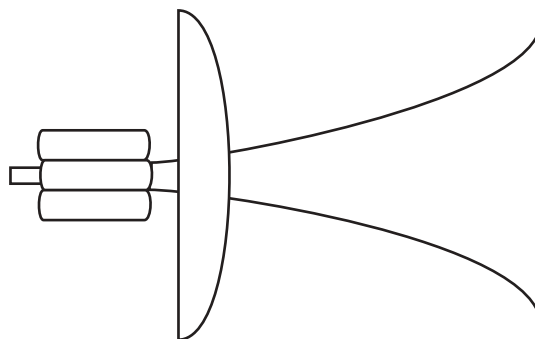

FUSION RAMJET

## 06 – References

Ardila, David R.; The Hidden Members of Planetary Systems; Scientific American, Vol. 290, No. 4; New York, NY; April 2004.

Ashley, Steven; Cryogenic Cutting: Liquid-Nitrogen Jet Slices and Scours Almost Anything; Scientific American, Vol. 290, No. 3; New York, NY; March 2004.

Audacious and Outragious; Science at NASA; NASA; [http://science.nasa.gov/headlines/y2000/ast07sep\\_1.htm](http://science.nasa.gov/headlines/y2000/ast07sep_1.htm); 2002.

Baard, Frank; Space 2100: To Mars and Beyond in the Century to Come; Popular Science; Time Inc. Home Entertainment; New York, NY; 2003.

Does Life Exist Elsewhere in Our Solar System?; Discover, Vol. 23, No. 5; Buena Vista Magazines; New York, NY; May 2002.

Dolci, Wendy; Planetary Embryoes Hatch in the Southern Constellation Centaurus; [http://www.nai.arc.nasa.gov/news\\_stories/news\\_detail.cfm?article=embryos.htm](http://www.nai.arc.nasa.gov/news_stories/news_detail.cfm?article=embryos.htm); 2004.

eInk: Technoogy: Cross-section of Electronic Ink Micro-capsules; <http://www.eink.com/technology/index.html>; 2002.

Helium 3; [www.space.com/scienceastronomy/helium3\\_000630.html](http://www.space.com/scienceastronomy/helium3_000630.html); 04 January 2004.

Jacobs, William.; The Hunt for Earth 2 Heats Up; Discover, Vol. 25, No. 2; Buena Vista Magazines; New York, NY; February 2004.

LISA: Opening a Whole New Window on the Universe: How LISA Works; <http://lisa.jpl.nasa.gov/TECHNOLOGY/challenges.html>; NASA; Jet Propulsion Laboratory, 2004.

Proposed Missions – Terrestrial Planet Finder; <http://www.jpl.nasa.gov/missions/proposed/tpf.html>; NASA; Jet Propulsion Laboratory; 2004.

Ratner, Mark and Ratner, Daniel; Nanotechnology: A Gentle Introduction to the Next Big Idea; Prentice Hall; Upper Saddle River, NJ; 2003.

Space Elevator Reference; What is a Space Elevator?; <http://www.spaceelevator.com/>; November 18, 2003.

Svitil, Kathy A.; Asteroids Get Spun By The Sun; Discover, Vol. 25, No. 2; Buena Vista Magazines; New York, NY; February 2004.

Weed, William Speed; Star Trek: Personnel Issues; Discover, Vol. 24, No. 8; Buena Vista Magazines; New York, NY; August 2003.

West, Krista; Storm Spotting: A Step Closer to Forecasting Disruptive Solar Activity; Scientific American, Vol. 290, No. 3; New York, NY, March 2004.

By the time it comes around commercial firms will control Lower Earth Orbit, space tourism will be "very viable", space-led power generation will be in production and there will be both small and large settlements on the Moon. The 300-person habitat in the moon's vicinity will house personnel to run mining operations. However, the report says that while they were focussing on what would have changed between the Earth and the Moon, they believe there would have been at least one manned mission to Mars by 2050. Just recently, the space agency has been testing its "flying saucer", which is set to be involved in delivering astronauts to the planet's surface. In other space news, Nasa has released new footage of its daring mission to land a probe on 'doomsday asteroid' Bennu and collect an alien sample. Nasa and Nokia are building a 4G network on the Moon. And, the Orionid meteor shower reaches its peak this week. Would you want to move to Mars? Let us know in the comments We pay for your stories! Do you have a story for The Sun Online Tech & Science team? At the 2050.earth website we've published detailed forecasts made by GReAT experts and futurologists from various countries for three milestones: 2030, 2040, and 2050. Basically, the site looks like an interactive globe: Choose a city and see what experts predict for it and its citizens. Predictions can apply to a city, a country, or the whole world. You can indicate agreement or disagreement with different forecasts by liking or disliking them, or write your own prediction and see how many people support your point of view. Bear in mind, our forecasters did a good job, making the globe so int